



DR. BUU NYGREN *PRESIDENT*
RICHELLE MONTOYA *VICE PRESIDENT*

The Navajo Nation | Yideeskáadi Nitsáhákees

April 3, 2023

TRANSMITTAL

TO : Calvin Castillo, Executive Director
 Division of Community Development (DCD)

FROM : CSH
 Cordell Shorley, Contracting Officer
 Contracts & Grants Section (CGS) / OMB

SUBJECT : Chinle Chapter House - ARPA Funds Allocated to Delegate Claw Region

I. Information on Contract (per Original Award):

Chinle Chapter House		U.S. Treasury American Recovery	
Title of Contract		Plan Act (ARPA)	21.027
CD-70-22	\$ 1,756,490.00	Funding Agency	CFDA No. - Federal
Grant No.	Amount	Fiscal Year	Term - Begin and End Date
		2022	03/11/2021 to 12/31/2026

II. Data Entered in FMIS Regarding:

- New Contract or Grant Company No. 8059 Business Unit (K#) K211583 - K211591
- Contract Mod No. Internal Modification No. 1
- Amt of Award Increase \$7,045,950.07 \$1,756,490.00 to \$8,802,340.07
- Budget Period - Extend End Date: From _____ To _____
- Other, specify: _____

Authorizing Document - Attached:

- Contract / Agreement - Date executed _____
- NNC / Committee Resolution - No. & Date _____
- Other, specify: NN Council Resolution CD-68-22

III. Comments by CGS:

Budget received on March 29, 2023 is authorized for implementation pursuant to FY 2023 NN BIM Appendix L Section II. B. and concurred by Navajo Nation Fiscal Recovery Fund (NN FRF) Office by memorandum of February 10, 2023. CGS previously entered budgets (K211578 to K211582) in the amount of \$1,756,490. Therefore, all budgets are now entered into FMIS for Resolution CD-70-22 in the amount of \$8,802,340.07. To not delay execution of allocation, CGS entered budget in FMIS although budgets did not comply with FY 2023 NN BIM Appendix L Section III. B. 3..

CSH
 Attachment
 Copy: Contract files
 Contract Accounting / OOC / DPM
 Tom Platero, Executive Director - NN FRF Office

Revised February 2023

(Ready for BU Setup)
As of February 10, 2023

F: CD-70-22: Council Delegate Shawna Claw		Approved NN Council Signed Resolution	Approved DOJ IED	Appendix A w/ Signatures	Budget Forms 1,2,4	Program Budget Summary	Approved Chapter Resolution	Amount	Notes	Ready for OMB
Ka1583 ✓	1. Chinle Chp Bathroom Additions Project	X	X	X	X	X	X	\$ 1,725,000.00	New DCD Exc Director signed budgets	22. X
Ka1594 ✓	2. Chinle Chp Earth and Dam Project	X	X	X	X	X	X	\$ 1,997,153.38	New DCD Exc Director signed budgets	23. X
Ka1585 ✓	3. Chinle Chp House Renovation Project	X	X	X	X	X	X	\$ 800,000.00	New DCD Exc Director signed budgets	24. X
Ka1586 ✓	4. Chinle Chp South Manuelito Well Traffic Study	X	X	X	X	X	X	\$ 15,000.00	New DCD Exc Director signed budgets	25. X
Ka1587 ✓	5. Chinle Chp Vendor Village Project	X	X	X	X	X	X	\$ 37,743.69	New DCD Exc Director signed budgets	26. X
Ka1588 ✓	6. Chinle Chp and Office of Dine Youth	X	X	X	X	X	X	\$ 50,000.00	New DCD Exc Director signed budgets	27. X
Ka1589 ✓	7. Chinle Chp CYEP and PEP Funding	X	X	X	X	X	X	\$ 1,150,953.00	New DCD Exc Director signed budgets	28. X
Ka1590 ✓	8. Chinle Chp Watering Point Pavement Project	X	X	X	X	X	X	\$ 70,000.00	New DCD Exc Director signed budgets	29. X
Ka1591 ✓	9. Chinle Chp Warehouse	X	X	X	X	X	X	\$ 1,200,000.00	New DCD Exc Director signed budgets	30. X
	Chinle/Ft. Defiance Alcohol and Substance Abuse Recovery Center - Day At A Time Club, Inc.	X	X	X	*	*	X	\$ 250,000.00	The appendix A is not fully signed or the copy does not show the signatures. There are no budget forms included.	
	11. Chinle Chp Equipment Project	X	X	X	X	X	X	\$ 288,500.00	The appendix A is not fully signed or the copy does not show the signatures.	
	12. Chinle Chp Wellness Center	X	X	X	X	X	X	\$ 750,000.00	The appendix A is not fully signed or the copy does not show the signatures. The budget forms do not have signatures.	
	13. Chinle Chp Emergency Funding	X	X	X	X	X	X	\$ 250,500.00	The appendix A is not fully signed or the copy does not show the signatures. The budget forms do not have signatures.	
	14. Chinle Chp N8095 Road Crossing Project	X	X	X	X	X	X	\$ 217,490.00	The appendix A is not fully signed or the copy does not show the signatures. The budget forms do not have signatures.	
	Total:							\$ 8,802,340.07		



DR. BUU NYGREN *PRESIDENT*
RICHELLE MONTOYA *VICE PRESIDENT*

The Navajo Nation | Yideeskáądi Nitsáhákees
MEMORANDUM

TO : Cordell Shortey, Contracting Officer
 Contracts & Grants Section/NN OMB

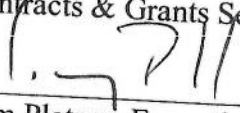
FROM : 
 Tom Platero, Executive Director
 Fiscal Recovery Fund Office/NN

DATE : February 10, 2023

SUBJECT : ARPA/FRF Chapter/Regional Expenditure Plans – CD-70-22
 Request to Set-up Project Accounts in FMIS/JDE



Of the 14 projects approved in CD-70-22, 9 of them have complete packages with the following documents:

1. DOJ issued Initial Eligibility Determination,
2. FRF Request Form & Expenditure Plan for either a) Non-Governance Certified Chapter or b) Governance Certified Chapter.
3. OMB Budget Forms 1, 2, 3 and 4 -**The budgets have been reviewed and re-signed by the newly appointed DCD Division Director – Mr. Calvin Castillo.**
4. OMB BIM Appendix J – Project Budget Schedule (i.e., Gantt Chart)
5. Chapter Resolutions and Other Supporting Documents.

The other 5 project packages are either missing documents and/or require revisions which the FRFO Staff are working with the Chapters to obtain.

Attached is a listing and a copy of the 9 project packets that are ready for Business Unit Accounts to be set-up in FMIS. We are requesting your office to set-up the 9 BU accounts in FMIS. The remaining 5 project packets will be sent to your office when they are complete.

Please contact our office if you have any questions or require any additional information. Thank you.

Cc: Tom Platero, FRFO Executive Direct
 Lisa Jymm, FRFO Deputy Director
 File

ATTACHMENTS

- Project Checklist CD-70-22
- 9 Project Packet Documents

NNDOJ
Initial Eligibility
Determination



NAVAJO NATION DEPARTMENT OF JUSTICE
OFFICE OF THE ATTORNEY GENERAL

DOREEN N. MCPAUL
Attorney General

KIMBERLY A. DUTCHER
Deputy Attorney General

DEPARTMENT OF JUSTICE
INITIAL ELIGIBILITY DETERMINATION
FOR NAVAJO NATION FISCAL RECOVERY FUNDS



RFS/HK Review #: HK0212

Date & Time Received: 11/15/22

Date & Time of Response: 11/28/2022 5:00 PM

Entity Requesting FRF: Chinle Chapter Government

Title of Project: Chinle Chapter and Office of Dine Youth

Administrative Oversight: Chapter President - Dr. Rosanna Jumbo-Fitch

Amount of Funding Requested: \$50,000

Eligibility Determination:

- FRF eligible
- FRF ineligible
- Additional information requested

FRF Eligibility Category:

- (1) Public Health and Economic Impact
- (2) Premium Pay
- (3) Government Services/Lost Revenue
- (4) Water, Sewer, Broadband Infrastructure

U.S. Department of Treasury Reporting Expenditure Category: 2.14 (Healthy Childhood Environments: Early Learning)

Returned for the following reasons (Ineligibility Reasons / Paragraphs 5. E. (1) - (10) of FRF Procedures):

- | | |
|--|--|
| <input type="checkbox"/> Missing Form | <input type="checkbox"/> Expenditure Plan incomplete |
| <input type="checkbox"/> Supporting documentation missing | <input type="checkbox"/> Funds will not be obligated by 12/31/2024 |
| <input type="checkbox"/> Project will not be completed by 12/31/2026 | <input type="checkbox"/> Incorrect Signatory |
| <input type="checkbox"/> Ineligible purpose | <input type="checkbox"/> Inconsistent with applicable NN or federal laws |
| <input type="checkbox"/> Submitter failed to timely submit CARES reports | |
| <input type="checkbox"/> Additional information submitted is insufficient to make a proper determination | |

Other Comments: _____

Name of DOJ Reviewer: Kristen A. Lowell

Signature of DOJ Reviewer: 

Disclaimers: This Initial Eligibility Determination is based on the documents provided which we have assumed are true, correct, and complete. Should the Project or Program change in any material way after this initial determination, the requestor must seek the advice of NNDOJ. This initial determination is limited to review of the Project or Program as it relates to whether the Project or Program is a legally allowable use – it does not serve as an opinion as to whether or not the Project or Program should be funded, nor does it serve as an opinion as to whether or not the amount requested is reasonable or accurate.

Appendix A

Per

BFS-31-21

THE NAVAJO NATION
FISCAL RECOVERY FUNDS REQUEST FORM & EXPENDITURE PLAN
FOR GOVERNANCE-CERTIFIED CHAPTERS

Part 1. Identification of parties.

Governance-Certified Chapter requesting FRF: Chinle Chapter Government Date prepared: 10-19-2022

Chapter's mailing address: PO BOX 1809 Chinle, AZ 86503 phone & email: (928) 674-2052
website (if any): chinle@navajochapters.org

This Form prepared by: Dr. Rosanna Jumbo-Fitch phone/email: (928) 225-1658
Chinle Chapter President rosanna.jumbo@naataanii.org
CONTACT PERSON'S name and title *CONTACT PERSON'S info*

Title and type of Project: Chinle Chapter and Office of Dine Youth

Chapter President: Dr. Rosanna Jumbo-Fitch phone & email: (928) 225-1658/rosanna.jumbo@naataanii.org

Chapter Vice-President: Shawna Claw phone & email: (928) 674-2052/sclaw@navajochapters.org

Chapter Secretary: Roann Burbank phone & email: (928) 674-2052/rburbank@navajochapters.org

Chapter Treasurer: Roann Burbank phone & email: (928) 674-2052/rburbank@navajochapters.org

Chapter Manager or CSC: Walton Yazzie, Manager phone & email: (505)910-9473/wyazzie@navajochapters.org

DCD/Chapter ASO: _____ phone & email: _____

List types of Subcontractors or Subrecipients that will be paid with FRF (if known): Not known

document attached

Amount of FRF requested: 50,000.00 FRF funding period: 2023-2026 10/1/23-9/30/25
indicate Project starting and ending/deadline date

Part 2. Expenditure Plan details.

(a) Describe the Program(s) and/or Project(s) to be funded, including how the funds will be used, for what purposes, the location(s) to be served, and what COVID-related needs will be addressed:

Chinle Chapter Government would assist the Office of Dine Youth in securing funds to complete ODY, Chinle, AZ building upgrades. The funds will be used for a new shower installation, new 40'X9' storage building, new utility sink, and PPE materials and equipment. The Office of Dine Youth will continue to serve those that are currently assisted through the Chinle Office of Dine Youth program.

document attached

(b) Explain how the Program or Project will benefit the Navajo Nation, Navajo communities, or the Navajo People:

The Chinle Chapter and Chinle Office of Dine Youth program will benefit the Navajo Nation, surrounding Navajo communities, and Navajo people through added plumbing, added storage, and added PPE supplies.

document attached

(c) A prospective timeline showing the estimated date of completion of the Project and/or each phase of the Project. Disclose any challenges that may prevent you from incurring costs for all funding by December 31, 2024 and/or fully expending funds and completing the Program(s) or Project(s) by December 31, 2026:

Chinle Chapter Government ODY Project timeline: Chinle Chapter resolution 10/17/2022, Navajo Nation and DOJ review submissions Winter 2022, Purchases Spring 2023- Fall 2023. Construction would be an estimated 6 months. Challenges would include Navajo Nation review timeline.

document attached

(d) Identify who will be responsible for implementing the Program or Project:

Chinle Chapter Government will be responsible for implementing the project and assistance.

document attached

(e) Explain who will be responsible for operations and maintenance costs for the Project once completed, and how such costs will be funded prospectively:

The Office of Dine Youth will be responsible for operations and maintenance costs for the project once completed.

document attached

(f) State which of the 66 Fiscal Recovery Fund expenditure categories in the attached U.S. Department of the Treasury Appendix 1 listing the proposed Program or Project falls under, and explain the reason why:

Healthy Childhood Environments: Early Learning*^ 2.14
Chinle Chapter is seeking funding for the Office of Dine Youth, Chinle AZ. The items include plumbing upgrades, storage additions, and overall PPE supplies.

document attached

Part 3. Additional documents.

List here all additional supporting documents attached to this FRF Expenditure Plan (or indicate N/A):

Chapter Resolution is attached, ODY budget, and ODY Manager email with clarifications on Scope of Work.

Chapter Resolution attached

Part 4. Affirmation by Funding Recipient.

Funding Recipient affirms that its receipt of Fiscal Recovery Funds and the implementation of this FRF Expenditure Plan shall be in accordance with Resolution No. CJY-41-21, the ARPA, ARPA Regulations, and with all applicable federal and Navajo Nation laws, regulations, and policies:

Chapter's Preparer: Rosanna Jumbo-Fitch
signature of Preparer/CONTACT PERSON

Approved by: Rosanna Jumbo-Fitch
signature of Chapter President (or Vice-President)

Approved by: [Signature]
signature of Chapter Manager or CSC

Approved by: _____
signature of DCD/Chapter ASO

Approved to submit for Review: Siva Jymm. NNFRFO
signature of DCD Director

Appendix J:
Project Budget
Summary
Per
CJN-29-22

**THE NAVAJO NATION
PROJECT BUDGET SCHEDULE**

PART I. Business Unit No.: <u>New</u> Project Title: <u>Chinle Office Dine Youth</u> Project Description: <u>Redo the restrooms, storage area, and PPE supplies</u> Check one box: <input checked="" type="checkbox"/> Original Budget <input type="checkbox"/> Budget Revision <input type="checkbox"/> Budget Reallocation <input type="checkbox"/> Budget Modification	PART II. Project Information: Project Type: <u>Chinle Office of Dine Youth</u> Planned Start Date: <u>10/1/2022</u> Planned End Date: <u>9/30/2025</u> Project Manager: <u>Walton Yazzie</u>
--	---

PART III. List Project Task separately, such as Plan, Design, Construct, Equip or Furnish. Hire two (2) Maintenance Technicians Purchase PPE supplies Purchase a storage box	Use Fiscal Year (FY) Quarters to complete the information below. O = Oct.; N = Nov.; D = Dec., etc.								Expected Completion Date if project exceeds 8 FY Qtrs.
	FY <u>2023</u>								
	1st Qtr. O N D	2nd Qtr. J F M X X X	3rd Qtr. A M J X X X	4th Qtr. J A S	1st Qtr. O N D	2nd Qtr. J F M	3rd Qtr. A M J	4th Qtr. J A S	
								O N D J F M	
\$	\$	\$	\$	\$	\$	\$	\$	\$	
\$	\$	\$	\$	\$	\$	\$	\$	PROJECT TOTAL	
	33,573.20	16,426.80						\$50,000.00	

FOR OMB USE ONLY: Resolution No: _____
 FMS Set Up Date: _____
 Company No: _____
 OMB Analyst: _____

Signed

Budget

Forms 1, 2 & 4

(Other budget forms if needed)

FY 2023

THE NAVAJO NATION
PROGRAM BUDGET SUMMARY

Page 1 of 4
BUDGET FORM 1

PART I. Business Unit No.: _____		New		Program Title: _____		Chinle Office of Dine Youth		Division/Branch: _____		DCD / Executive Branch	
Prepared By: <u>Walton Yazzie</u>		Phone No.: _____		928.674.2052		Email Address: _____		<u>wyazzie@nnchapters.org</u>			
PART II. FUNDING SOURCE(S)		Fiscal Year /Term	Amount	% of Total	PART III. BUDGET SUMMARY						
NIN Fiscal Recovery Funds		FY 23-FY25	50,000.00	100%	Fund Type Code	(A) NNC Approved Original Budget	(B) Proposed Budget	(C) Difference or Total			
		<u>10/1/20-9/30/25</u>			2001 Personnel Expenses						
					3000 Travel Expenses						
					3500 Meeting Expenses						
					4000 Supplies						
					5000 Lease and Rental						
					5500 Communications and Utilities						
					6000 Repairs and Maintenance						
					6500 Contractual Services						
					7000 Special Transactions						
					8000 Public Assistance	6	50,000	50,000			
					9000 Capital Outlay						
					9500 Matching Funds						
					9500 Indirect Cost						
					TOTAL		\$0.00	50,000.00	50,000		
PART IV. POSITIONS AND VEHICLES					(D)	(E)					
TOTAL: \$50,000.00					2	2					
TOTAL: 100%					0	0					
PART V. I HEREBY ACKNOWLEDGE THAT THE INFORMATION CONTAINED IN THIS BUDGET PACKAGE IS COMPLETE AND ACCURATE.											
SUBMITTED BY: _____		Walton Yazzie		Program Manager's Printed Name		APPROVED BY: _____		Lisa Symm		Division Director / Branch Chief's Printed Name	
_____		_____		_____		_____		_____		_____	
_____		_____		_____		_____		_____		_____	



Walton Yazzie 2/9/2023
Signature and Date

Lisa Symm
Signature and Date

THE NAVAJO NATION
PROGRAM PERFORMANCE CRITERIA

FY 2023

PART I. PROGRAM INFORMATION:		Business Unit No.: <u>New</u>		Program Name/Title: <u>Chinle Office of Dine Youth</u>	
PART II. PLAN OF OPERATION/RESOLUTION NUMBER/PURPOSE OF PROGRAM:					
PART III. PROGRAM PERFORMANCE CRITERIA:					
1. Goal Statement:	install showers and other related work duties	1st QTR		4th QTR	
Program Performance Measure/Objective:		Goal	Actual	Goal	Actual
Hire two (2) Maintenance Technicians				2	
2. Goal Statement:	Safer place to work	2nd QTR		3rd QTR	
Program Performance Measure/Objective:		Goal	Actual	Goal	Actual
Purchase PPE supplies				1	
3. Goal Statement:	Need a place to store PPE supplies	2nd QTR		3rd QTR	
Program Performance Measure/Objective:		Goal	Actual	Goal	Actual
Purchase a Storage box				1	
4. Goal Statement:		2nd QTR		3rd QTR	
Program Performance Measure/Objective:		Goal	Actual	Goal	Actual
5. Goal Statement:		2nd QTR		3rd QTR	
Program Performance Measure/Objective:		Goal	Actual	Goal	Actual
6. Goal Statement:		2nd QTR		3rd QTR	
Program Performance Measure/Objective:		Goal	Actual	Goal	Actual
PART IV. I HEREBY ACKNOWLEDGE THAT THE ABOVE INFORMATION HAS BEEN THOROUGHLY REVIEWED.					
Program Manager's Printed Name <u>Walton Yazzie</u>		Division Director/Branch Chief's Printed Name <u>Lisa Jymm</u>			
Program Manager's Signature <u>[Signature]</u>		Division Director/Branch Chief's Signature and Date <u>[Signature] 2/9/2022</u>			

PART I. PROGRAM INFORMATION: Program Name/Title: <u>Chinle Office of Dine Youth</u> Business Unit No.: <u> </u> New			
PART II. DETAILED BUDGET:			
(A)	(B)	(C)	(D)
Object Code (LOD 6)	Object Code Description and Justification (LOD 7)	Total by DETAILED Object Code (LOD 6)	Total by MAJOR Object Code (LOD 4)
8000 8705 8710 8740	Assistance Chapter PEP Emergency <i>Complete Chinle ODY building upgrades and assist youth in the community.</i>	 32,854 17,146	50,000
TOTAL			50,000

1206

* No justification - 9/17 6/31/23

Chapter Resolutions
and Other
Supporting
Documents

Chinle Chapter Government

THE NAVAJO NATION

Dr. Rosanna Jumbo-Fitch
PRESIDENT

Shawna Claw
VICE PRESIDENT

RoAnn Burbank
SECRETARY/TREASURER

Eugene Tso
COUNCIL DELEGATE

Oscar Bia
GRAZING COMMITTEE MEMBER

RESOLUTION OF THE CHINLE CHAPTER NAVAJO NATION CHIN-OCT-22-083

APPROVING THE SELECTION OF THE CHAPTER OFFICE OF DINE YOUTH PROJECT FOR THE INCLUSION ON THE CHINLE CHAPTER DELEGATE REGION IN THE AMOUNT OF \$50,000.00.

WHEREAS:

1. Pursuant to Navajo Nation Code, Section 4001 (d) and 4028 (2), (b) the Chinle Chapter is established and certified as a local government entity of the Navajo Nation, and has the authority to review all matters affecting the chapter and submit appropriate recommendations to the Navajo Nation government of other local agencies by resolutions; and
2. To support the efforts of the Navajo Nation to mitigate the effects of the COVID-19 Pandemic, the American Rescue Plan Act (ARPA) Fiscal Recovery Funds were allocated to develop the basic infrastructure to improve lives of people who have lived without water, electricity and basic services to support their daily activities, health, and welfare"; and
3. The Navajo Nation Council approved CHIN-29-22, in response to the COVID-19 Pandemic in the best interest of the people: "An Action Relating to the Naabik'iyati Committee and Navajo Nation Council; Allocating \$1,070,298,867 of Navajo Nation Fiscal Recovery Funds; Approving the Navajo Nation Fiscal Recovery Fund Expenditure Plans for: Chapter Assistance; Public Safety; Emergency Communications; E911; and Rural Addressing Projects; Cyber Security; Public Health Projects; Economic Development Projects; Hardship Assistance; Water and Wastewater Projects; Broadband Projects; Home Electrical Connection and Electricity Capacity Projects; Housing Projects and Manufactured Housing Facilities; Bathroom Addition Projects; Construction Contingency Funding; and Reduced Administrative Funding"; and
4. The Chinle Chapter Government has attended several meetings with Navajo Nation Division of Community Development, Navajo Tribal Utility Authority, and the Fiscal Recovery Fund Office; and
5. The eligible attached Exhibit: Chinle Chapter Office of Dine Youth was selected as a Project to be included on the Navajo Nation Council Delegate Eugene Tso Chapter Region in the amount of \$50,000.00 for the Chinle Chapter; and
6. The total amount for Chinle Chapter Delegate Region is \$850,340.00.

NOW, THEREFORE BE IT RESOLVED THAT:

1. The Chinle Chapter Government hereby approves the selection of Chinle Chapter Office of Dine Youth was a selected Project to be included on the Navajo Nation Council Delegate Eugene Tso Chapter Region in the amount of \$50,000.00.

CERTIFICATION

We hereby certify that the foregoing chapter resolution was duly considered by the Chinle Chapter at a duly called meeting at which time a quorum was present. A motion was made by Oscar Bia Sr. and seconded by Walton Yazzie and the same was passed by a vote of 7 in favor, 0 opposed, and 3 abstained, this 17th day of October, 2022.

Dr. Rosanna Jumbo-Fitch, President

Shawna Claw, Vice Presidents

RoAnn Burbank, Secretary/Treasurer

PO Box 1809 Chinle, Arizona
86503

• P: (928) 674-2052 • F: (928) 674-2079 • chinle@navajochapters.org



Rosanna Jumbo <rosanna.jumbo@naataanii.org>

ODY

Al Tsedah <altsedah@yahoo.com>

Thu, Oct 20, 2022 at 1:56 PM

To: Walton Yazzie <wyazzie@nnchapters.org>, Rosanna Jumbo <rosanna.jumbo@naataanii.org>

The personnel positions will complete installation of shower stalls and drainage sink. The scope of work is to complete the project within 6-months.

The showers are to be use by the youth participants during any activity provided by Office of Dine Youth. Today, our youth participants sometimes would execute an accident (meaning: dirty themselves) and need attention to clean themselves quickly through taking a shower. Not all youth participants have access to running water or plumbing at their home, and when they participate in our physical activities, some will need to cleanse themselves before going home. Our promotion is always, self-care through washing up and keep hygienically sanitized.

The drainage sink at the Boys & Girls Club is much needed. Right now, there is not drainage sink for any janitorial related cleaning, most time water is drained outside of the building. With this installation, a lot more and improvement of draining of dirty used water can be drained in doors. The Club will be in compliance with OEH standards as well. Drainage sink is much essential to clean, sanitize, and mop as everyday general cleaning.

The storage is desired to safe keep all our essentials, our recreation equipment & supplies, our personal protective equipment & supplies. We stopped partnering up with other entities on getting cleaning and sanitation supplies to distribute to our youth during Covid19 era, because we have no storage to safeguard the supplles. The storage will help tremendously to keep our cleaning supplies fresh to distribute and to keep our equipment safe.

The PPE will be purchased to continue to distribute to our youth within our areas (agency) to keep them safe from any disease contractions.

Thank you, and hope this helps..

Al Tsedah

(Quoted text hidden)

ODY \$ 50,000.00
BUDGET for NEEDS IMPROVEMENT

I.	PERSONNEL	32,853.60
	To hire (2) Maintenance Technicians at entry level pay to do plumbing work. Install janitorial sink and shower stalls. Maintenance Technicians will perform journey level skilled repair and maintenance work in any of several trades such as plumbing, carpentry, painting, building maintenance, and appliances repair and maintenance; will perform related work as assigned.	
	$\$15.63 \times 960 \text{ hours} \times 2 = \$ 30,009.60$	
	$30,009.60 \times 9.48\% = 2,844.00$	
	TOTAL: \$ 32,853.60	
II	IMPROVEMENT PROJECTS: INSTALL SHOWERS & SINK	3,519.40
	Listing of supplies and installation kits are included in the packet.	
III	STORAGE BOX	10,000.00
	Storage is needed to store PPE supplies and other regularly used equipment, such as recreational equipment, tent, canopies, tables, chairs, etc. Safe keeping of these items is necessary and much in need.	
IV	MEDICAL SUPPLIES/PPE	3,627.00
	Will purchase cleaning supplies, sanitizers, disinfect wipes, personal hygienes, facial mask, etc. to keep for office cleaning and to distribute to youth at all ODY events as part of prmoting and encouraging safety and prevention.	
	GRAND TOTAL:	\$50,000.00

Please accept the forthgoing budget of the \$50,000.00 requested from Office of Dine YOUTH as part of ARPA funding distribution to the Chapter. Our request was approved at your Chapter Meeting through a resolution. Thank you.

Submitted by:
Al Tsedah, Program Supervisor III
Chnle ODY/BGC - Chinle Agency
928-674-2066

Your Cart (12)

[Share](#)

[Remove All Items](#)

[Checkout](#)

FREE Shipping on eligible items. [View Details](#)



OATEY Round Gray PVC Shower Drain with 4-1/4 in. Round Snap-In Stainless Steel Drain Cover

Model #420452

\$20.76

(\$10.38/item)

2

Store Pickup
18 in stock at
Gallup
87301

FREE

Ship To Home
Order within 6 hrs 17 mins get it by Mon, Oct 17

FREE

Scheduled Delivery
Starting at \$8.99 for delivery as soon as today

[How It Works](#)

[Save for Later](#) [Save to Favorites](#) [Remove](#)

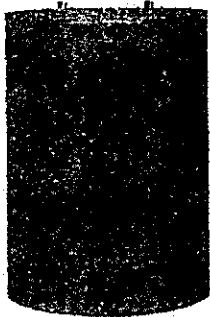

Rheem Performance 30 Gal. Short 6 Year 4500/4500-Watt Elements Electric Tank Water Heater

Tank Warranty: 6 Year
Nominal Tank Capacity (gallons)

\$519.00

Ship To Store
Oct. 21-Oct. 26
Gallup
87301

FREE

Ship To Home
Estimated Arrival:
Fri, Oct 28

\$55.00

Scheduled Delivery
Starting at \$8.99 for delivery as soon as today

[How It Works](#)

Add a Home Depot Protection Plan by Allstate?
5-year Protection for \$69.00

[Learn More](#)

[Save for Later](#) [Save to Favorites](#) [Remove](#)

Mueller Streamline 1/2 in. x 10 ft. Copper Type L Pipe

Model #LH04010

\$46.52

(\$23.26/item)

Get Bulk Pricing of \$18.61 on this item when you purchase at least 10 units.

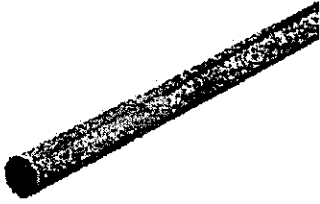

2

Store Pickup
22 in stock at
Gallup
87301 | Change

FREE

Ship To Home

Scheduled Delivery
Starting at \$8.99 for delivery as soon as tomorrow

How It Works

Curbside Available

[Save for Later](#) [Save to Favorites](#) [Remove](#)

SnappyTrap 1-1/2 in. All-in-One Drain Kit for Single Bowl Kitchen Sinks, Bar Sinks and Utility Sinks

Model #DK-100

\$17.84

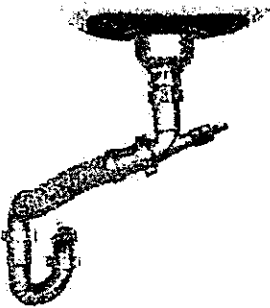

1

Store Pickup
10 in stock at
Gallup
87301

FREE

Ship To Home
Order within 6 hrs 17 mins get it by Mon, Oct 17

FREE

Scheduled Delivery
Starting at \$8.99 for delivery as soon as tomorrow

How It Works

[Save for Later](#) [Save to Favorites](#) [Remove](#)

MOEN Adler Single-Handle 4-Spray Shower Faucet in Chrome (Valve Included)

Model #82604

\$178.00

(\$89.00/item)

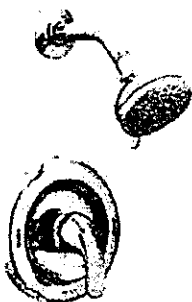

2

Store Pickup
12 In stock at
Gallup
87301

FREE

Ship To Home
Order within 6 hrs 17 mins get it by Mon, Oct 17

FREE

Scheduled Delivery
Starting at \$8.99 for delivery as soon as today

How It Works

Save for Later Save to Favorites Remove



TEHILA Complete 22.875 in. x 23.5 in. White 19 Gal. Utility Sink Set with Black Metal Hybrid Faucet and Soap Dispenser

Model #040 US6507

\$233.30



1

Ship To Store
Oct. 18–Oct. 20
Gallup
87301 | Change

FREE

Ship To Home

FREE

Scheduled Delivery
Not Available for this item

Curbside Available

Save for Later Save to Favorites Remove

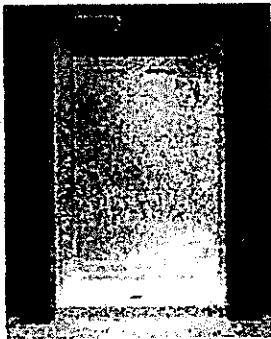

DreamLine SlimLine 48 in. x 32 in. Single Threshold Shower Base in White with Shower Backwalls

Model #DL-6070C-01

\$2,379.98

(\$1,189.99/item ~~\$1,252.75~~)

Save 5%

2

Ship To Store
Oct. 25–Oct. 28
Gallup
87301 | Change

FREE

Ship To Home

Scheduled Delivery
Not Available for this item

Curbside Available

Subtotal	\$3,589.92
Savings	-\$125.52
Estimated Shipping*	\$55.00
Pick Up In Store	FREE
Sales Tax (determined in later step)	---
Total	\$3,519⁴⁰

You Saved 3% Off Your Items

Have a promo code?

* Shipping and delivery charges are calculated at the lowest rate available. Other methods will be viewable on the next page.

Checkout

— or —



Easy In-Store and Online Returns
Read our Return Policy

Customers Also Purchased...

Best Seller



BrassCraft 3/8 In. Compression x 1/2 in. FIP x 20 in.

~~\$17.20~~

Add To Cart

Exclusive



BrassCraft 3/8 In. Compression x 7/8 in. Ballcock Nut x

~~\$6.45~~

Add To Cart



Everbilt 1-1/2 in. White Plastic Sink Drain P-Trap with

\$4.94

Add To Cart



Glacier Bay All-in-One 24 in. x 24 in. 20 Gal.

~~\$164.00~~

Add To Cart

Best Seller



SnappyTrap Universal Drain Kit for Bathroom

\$15.78

Add To Cart



Fluidmaster Better Than Wax Universal Wax-

~~\$13.57~~

Add To Cart



SharkBrite Push-In 3/8 in.

\$12.45

Add To Cart

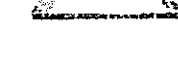
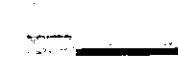
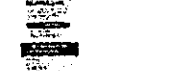
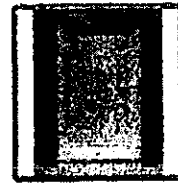
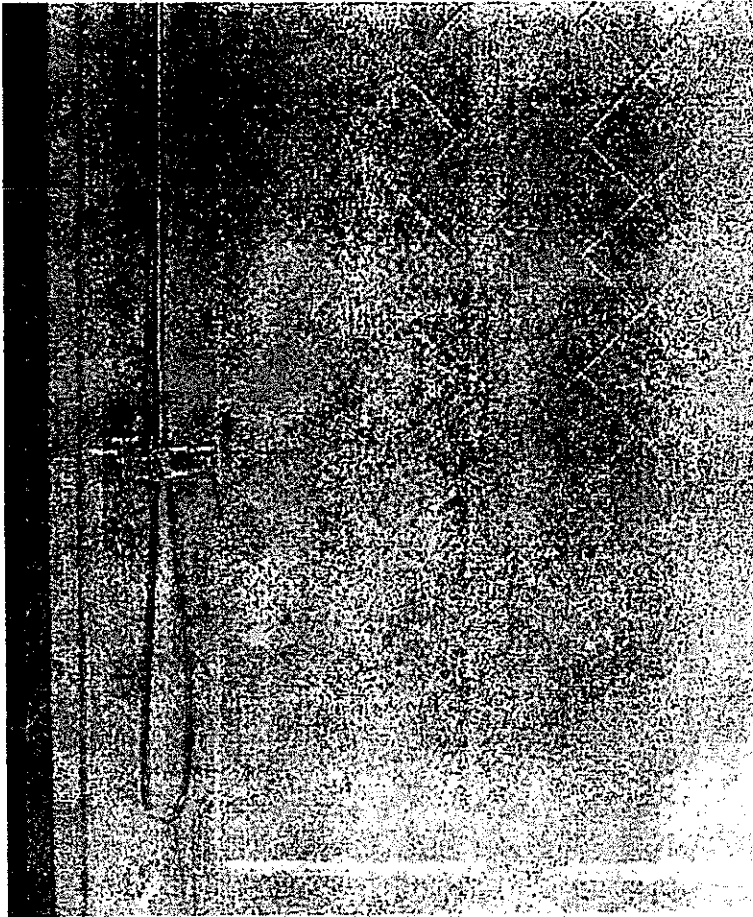

 Live Chat

 Feedback

Close X

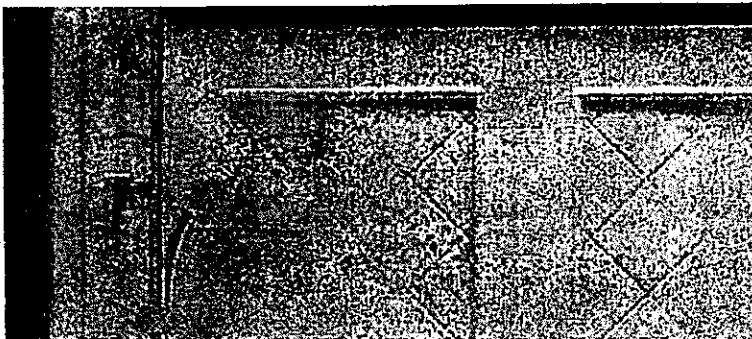

SlimLine 48 in. x 32 in.
Single Threshold Shower
Base in White with
Shower Backwalls

by DreamLine

Product Images

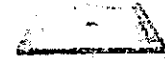
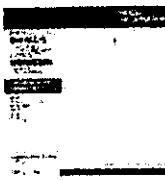
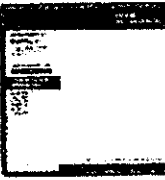
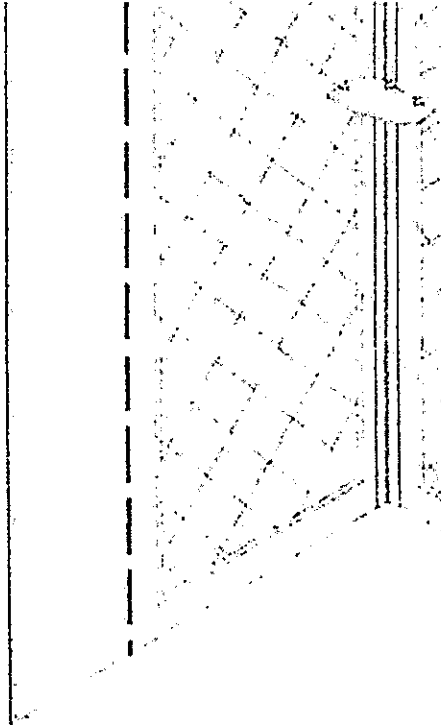

Feedback Live Chat

Close X

SlimLine 48 in. x 32 in.
Single Threshold Shower
Base in White with
Shower Backwalls

by DreamLine

Product Images

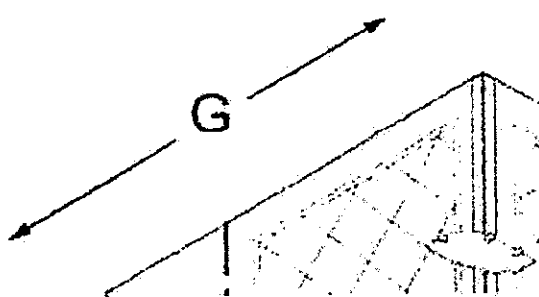

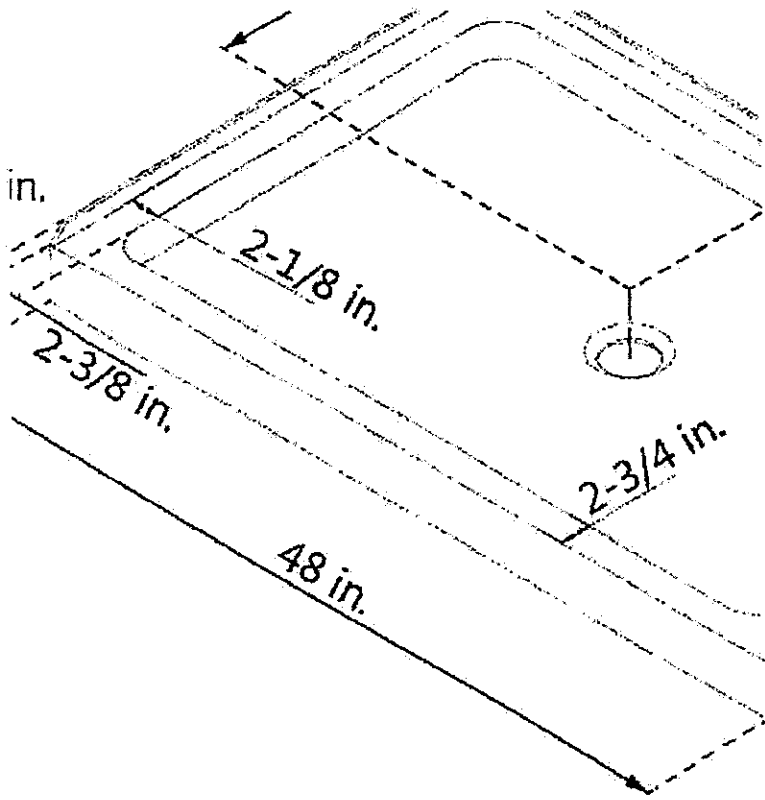

DreamLine reserves

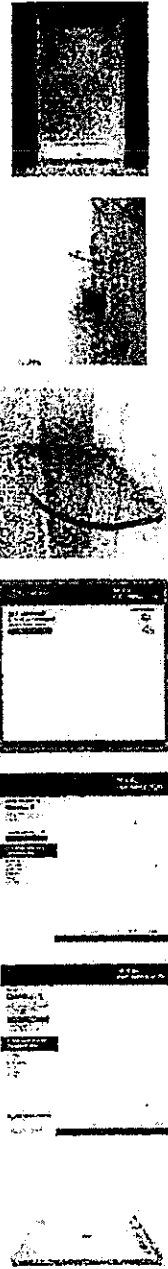

Live Chat

Feedback

Close X

RAIN

SlimLine 48 in. x 32 in.
Single Threshold Shower
Base in White with
Shower Backwalls

by DreamLine



Product Images

MAINTENANCE TECHNICIAN

DEFINITION: Under general supervision, performs journey level skilled repair and maintenance work in any of several trades such as plumbing, carpentry, painting, building maintenance, and appliance repair and maintenance; performs related work as assigned.

ESSENTIAL FUNCTIONS: This list is ILLUSTRATIVE ONLY and is not a comprehensive listing of all functions and tasks performed by incumbents of this class.

TASKS:

Performs general maintenance and carpentry and cabinet-making work; installs cabinets and shelves; frames walls; repairs and replaces doors, windows, casing, garage doors, roof and carpet; installs flooring; performs plumbing activities, installing new plumbing including pipes, drains, tubs, faucets, sinks, and other plumbing fixtures and equipment; makes repairs on old plumbing; repairs breaks; replaces washers and valves; clean and opens drains and water lines; performs painting activities by preparing surface to be painted including sanding, scraping, patching, priming and texturing surfaces, mixes and applies paints to surfaces; mixes and applies plaster.

Performs installation, alteration, maintenance and repair of wiring systems and electrical fixtures and equipment; replace fuses, bulbs and globes; maintains, repairs or replaces residential type appliance such as water coolers, refrigerators, etc.; maintains, repairs or replaces heating ventilation and air conditioning units; checking Freon pressure; removes or recycles refrigerant; inspects fans, condensers, blower motors, heating and cooling units, wiring, etc.; services common household appliances; inspects damage to determine scope of work; estimates materials and supplies needed to complete work; re-keys and masters all locks; cleans and repairs tools and equipment.

Performs on call emergency duties for major outages, sewer backups, etc; provides cross training for co-workers and acquires cross training in other trades areas; installs security alarm systems; winterizes and summarizes heating units and air conditioners; provides preventive maintenance and troubleshooting; locates gas or water leaks; checks units for proper operation; performs preventive maintenance program through scheduled inspection and servicing of equipment, housing and facilities; maintains a clean and safe work environment.

KNOWLEDGE, SKILLS AND OTHER CHARACTERISTICS:

Knowledge of common practices, methods, materials and tools of various journey level building, electrical, and plumbing trades.

Knowledge of National Electric Code, Plumbing Code, Building Code and Plumbing Code.

Knowledge of hazards and safety precautions of various trades.

Knowledge of power and technical tool operation related to appliance repair and maintenance.

Knowledge of installation and programming of security alarm systems.

Knowledge of occupational safety and health regulations and practices.

Skill in troubleshooting and repairing a variety of commercial and residential appliances.

Skill in performing semi-skilled tasks of various trades.

Skill in safely working with potentially hazardous materials, chemicals and supplies.

Skill in prioritizing and handling multiple assignments.

Skill in maintaining and repairing power and hand tools and equipment.

Skill in establishing and maintaining effective working relationships.

Skill in welding.

THE NAVAJO NATION

Class Code: 4077
General Services and Maintenance Series
Maintenance Group
Overtime Code: Non-Exempt
Pay Grade: 60

MAINTENANCE TECHNICIAN

Ability to read and work from blueprints, shop drawings and sketches.
Ability to learn relevant building, fire and safety codes.

PHYSICAL REQUIREMENTS AND WORK ENVIRONMENT: Work requires extended hours working, lifting, carrying and transporting heavy tools, appliances, material and equipment weighing in excess of 100 pounds; requires climbing, kneeling, bending stooping and working in confined spaces.

MINIMUM QUALIFICATIONS:

- A high school diploma/GED; and three (3) years of general building maintenance experience in one or more trades area; or an equivalent combination of education and experience.

Special Requirements:

- Possess a valid state driver's license.

PREFERRED QUALIFICATIONS:

- Journeyman level certification
- Occupational Safety and Health Administration training.
- HVAC training or certification.

Supplemental Requirements:

Incumbent must obtain a Navajo Nation Vehicle Operator's Permit within 90 days of date of hire.

Depending upon the needs of the Nation, some incumbents of the class may be required to demonstrate fluency in both the Navajo and English languages as a condition of employment.

MAINTENANCE TECHNICIAN

DEFINITION: Under general supervision, performs journey level skilled repair and maintenance work in any of several trades such as plumbing, carpentry, painting, building maintenance, and appliance repair and maintenance; performs related work as assigned.

ESSENTIAL FUNCTIONS: This list is ILLUSTRATIVE ONLY and is not a comprehensive listing of all functions and tasks performed by incumbents of this class.

TASKS:

Performs general maintenance and carpentry and cabinet-making work; installs cabinets and shelves; frames walls; repairs and replaces doors, windows, casing, garage doors, roof and carpet; installs flooring; performs plumbing activities, installing new plumbing including pipes, drains, tubs, faucets, sinks, and other plumbing fixtures and equipment; makes repairs on old plumbing; repairs breaks; replaces washers and valves; clean and opens drains and water lines; performs painting activities by preparing surface to be painted including sanding, scraping, patching, priming and texturing surfaces, mixes and applies paints to surfaces; mixes and applies plaster.

Performs installation, alteration, maintenance and repair of wiring systems and electrical fixtures and equipment; replace fuses, bulbs and globes; maintains, repairs or replaces residential type appliance such as water coolers, refrigerators, etc.; maintains, repairs or replaces heating ventilation and air conditioning units; checking Freon pressure; removes or recycles refrigerant; inspects fans, condensers, blower motors, heating and cooling units, wiring, etc.; services common household appliances; inspects damage to determine scope of work; estimates materials and supplies needed to complete work; re-keys and masters all locks; cleans and repairs tools and equipment.

Performs on call emergency duties for major outages, sewer backups, etc; provides cross training for co-workers and acquires cross training in other trades areas; installs security alarm systems; winterizes and summarizes heating units and air conditioners; provides preventive maintenance and troubleshooting; locates gas or water leaks; checks units for proper operation; performs preventive maintenance program through scheduled inspection and servicing of equipment, housing and facilities; maintains a clean and safe work environment.

KNOWLEDGE, SKILLS AND OTHER CHARACTERISTICS:

Knowledge of common practices, methods, materials and tools of various journey level building, electrical, and plumbing trades.

Knowledge of National Electric Code, Plumbing Code, Building Code and Plumbing Code.

Knowledge of hazards and safety precautions of various trades.

Knowledge of power and technical tool operation related to appliance repair and maintenance.

Knowledge of installation and programming of security alarm systems.

Knowledge of occupational safety and health regulations and practices.

Skill in troubleshooting and repairing a variety of commercial and residential appliances.

Skill in performing semi-skilled tasks of various trades.

Skill in safely working with potentially hazardous materials, chemicals and supplies.

Skill in prioritizing and handling multiple assignments.

Skill in maintaining and repairing power and hand tools and equipment.

Skill in establishing and maintaining effective working relationships.

Skill in welding.

THE NAVAJO NATION

Class Code: 4077
General Services and Maintenance Series
Maintenance Group
Overtime Code: Non-Exempt
Pay Grade: 60

MAINTENANCE TECHNICIAN

Ability to read and work from blueprints, shop drawings and sketches.
Ability to learn relevant building, fire and safety codes.

PHYSICAL REQUIREMENTS AND WORK ENVIRONMENT: Work requires extended hours working, lifting, carrying and transporting heavy tools, appliances, material and equipment weighing in excess of 100 pounds; requires climbing, kneeling, bending stooping and working in confined spaces.

MINIMUM QUALIFICATIONS:

- A high school diploma/GED; and three (3) years of general building maintenance experience in one or more trades area; or an equivalent combination of education and experience.

Special Requirements:

- Possess a valid state driver's license.

PREFERRED QUALIFICATIONS:

- Journeyman level certification
- Occupational Safety and Health Administration training.
- HVAC training or certification.

Supplemental Requirements:

Incumbent must obtain a Navajo Nation Vehicle Operator's Permit within 90 days of date of hire.

Depending upon the needs of the Nation, some Incumbents of the class may be required to demonstrate fluency in both the Navajo and English languages as a condition of employment.